



ETCH™
DECORATIVE FABRIC

EX
E
T
I
A



AUTEX INDUSTRIES

ETCH™ DECORATIVE FABRIC

Etch is a visual layer of expression, a wall fabric combining design, colour and texture. Available in a pallet of 28 colours, choose from 15 standard patterns or Etch your own custom design.

Etch is suited for overlaying directly to your chosen surface or choose to incorporate one of Autex's acoustic backing options to provide a selectable range of acoustic absorption.

Etch is a decorative, functional and durable interior finish suitable for commercial offices, theatres, libraries, retail, hospitality and education spaces.

Etch represents Autex and our commitment to innovation; Etch, create great space.

APPLICATIONS

- Decorative and functional wallcovering for education, commercial offices, theatres, libraries, retail, and hospitality sectors
- Custom pattern design available
- Use in conjunction with other Autex Interior Acoustic products for a complete interior solution

SPECIFICATION:

Roll 3mm (nom.) depth, colour (L),
Fire Rating ISO 9705: Classification:
Group 1-S, AS ISO 9705 – 2003
Classification: Group 1, EN13501-1:2007+A1:
2009: B - s1, d2

Install as per Autex recommendations.

If Etch is to be specified for use other than as a wallcovering, please seek guidance from your Autex Account Manager.



Autex Industries

PRODUCT SPECIFICATIONS

Product Name	Etch
Composition	100% Polyester Fibre (PET)
Drop Width	1.3m
<small>Other widths are available on request, minimum order quantity applies</small>	
Thickness	3-4mm
Weight	Typically 400gsm
Finish	Available in fine velour

INSTALLATION

Install as per Autex recommendations.

FASTNESS TO LIGHT

Veriface® is suitable for indoor use only and has been tested to the following standard:

ISO 105-B02-1994 (Grey Scale 1-5)

Light Fastness Rating: 3

ACOUSTIC PERFORMANCE

Etch can be paired with other Autex Interior Acoustic products to create your desired acoustic performance. Please speak to your Autex Account Manager for guidance and options.

LIGHT REFLECTIVE VALUES BY COLOUR

Sanz	35.81	Avocado	10.87
Lime	28.98	Blush	10.30
Azure	24.19	Sage	8.99
Jade	21.98	Blazing Red	7.85
Porcelain	21.64	Raspberry	7.64
Fawn	20.30	Cinder	5.07
Granny Smith	19.72	Octane	4.78
Stonewash	18.94	Phantom	3.88
Simba	17.56	Theatre	3.34
Brilliant Orange	15.31	Stately	3.24
Spearmint	13.32	Charcoal	3.17
Calypso	12.66	Lightsout	2.61
Electric Blue	12.15	Ink	2.55
Koala	11.86	Noir	1.16

FIRE RATINGS

ISO 9705: 1993

Classification: Group 1-S

Smoke Production Rate: <5.0m²/s

As required by NZBC C/VM2

AS ISO 9705 - 2003

Classification: Group 1

(SMOGR_{ARC}): <100m²/s²

As required by BCA C1.10

FI 4906 dated 11th July, 2012

EN13501-1:2007+A1:2009

B - s1, d2

WF 336910 dated 25th February, 2014

VOC EMISSIONS

Autex polyester has been tested by Cetec Pty Ltd (Report: CV080408) for chemical emission and is classified as low VOC.

VOC concentration: 0.01 mg/m³



W
E
L
C
O
M
E

PICK YOUR **BACKING**

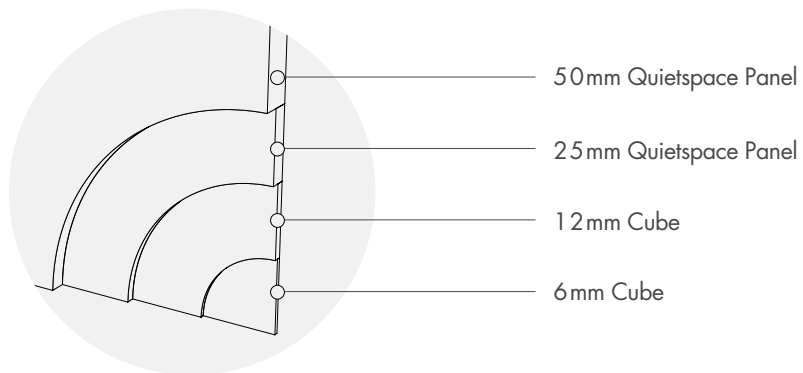
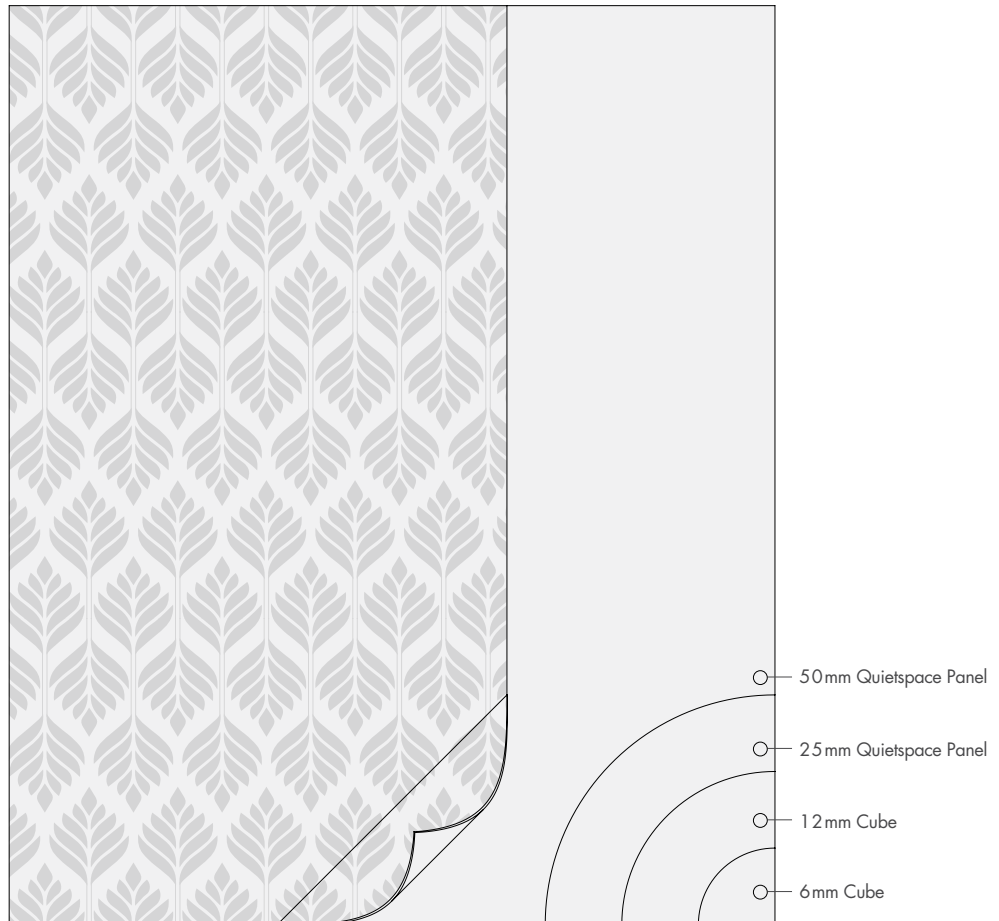



A
 U
 T
 E
 X
 I
 N
 D
 U
 S
 T
 R
 I
 E
 S

ETCH™

PICK YOUR BACKING

Acoustic testing to ISO 354. University of Auckland Testing Service Report
 25mm Test: T0712. 50mm Test: T0712-13. 75mm Test: T1409-5. 100mm Test: T1409-3.
 Cube 6mm - Test No. T0712, 12mm - Test No. T07123

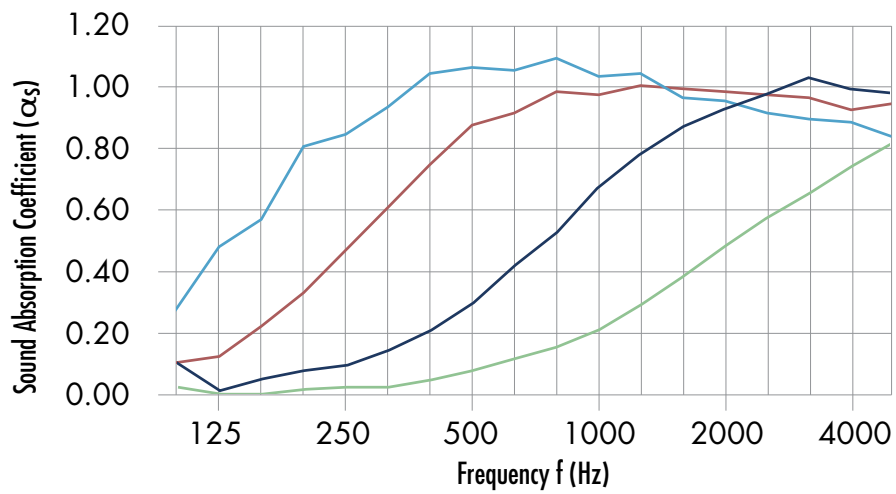

Frequency (Hz)	125	250	500	1000	2000	4000	NRC
6mm Cube	0.00	0.02	0.07	0.20	0.46	0.71	0.20
12mm Cube	0.00	0.08	0.28	0.64	0.89	0.96	0.45
25mm Quietspace Panel	0.12	0.47	0.88	0.98	0.99	0.93	0.85
50mm Quietspace Panel	0.48	0.85	1.07	1.04	0.96	0.89	1.00

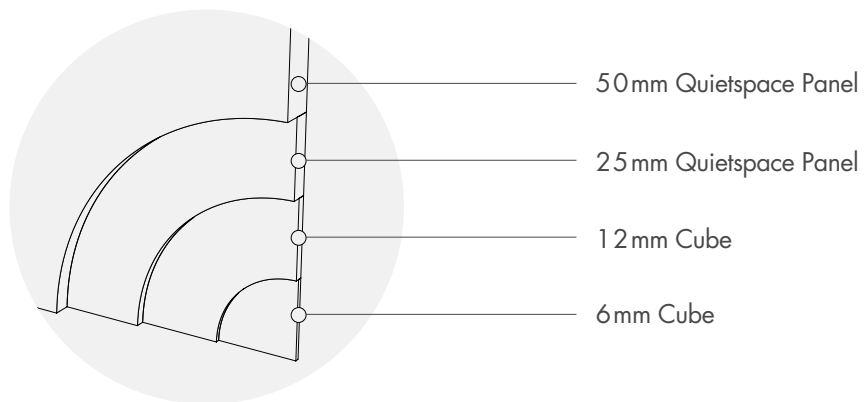



W
E
L
C
O
M
E

ETCH™

PICK YOUR **COLOUR**

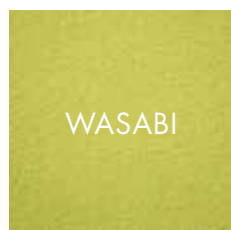

WASABI



LIME



JADE



AVOCADO

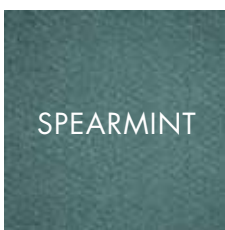

SPEARMINT



GRANNY
SMITH

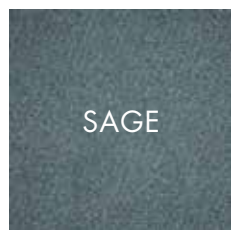

SAGE

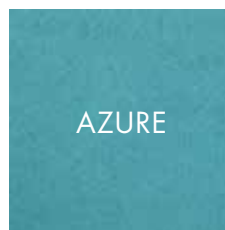

AZURE

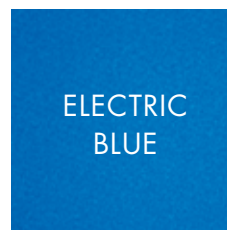

ELECTRIC
BLUE

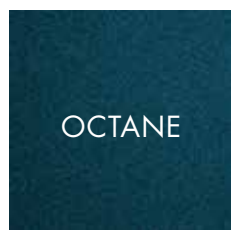

OCTANE

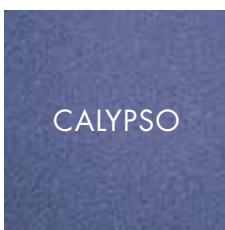

CALYPSO

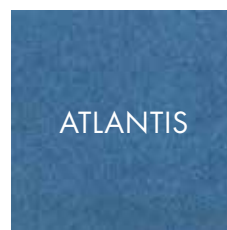

ATLANTIS

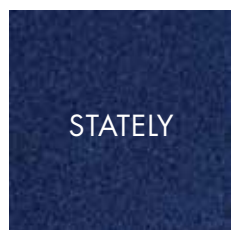

STATELY



INK

AUTEX 



W
E
L
C
O
M
E

ETCH™

PICK YOUR **COLOUR**

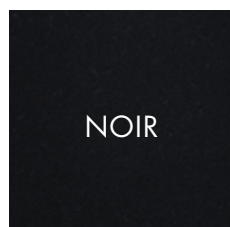
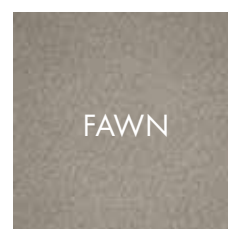
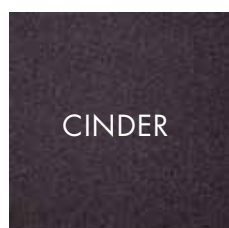
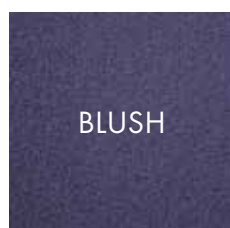
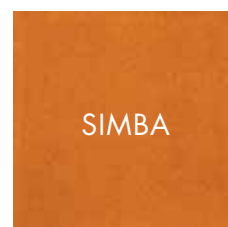
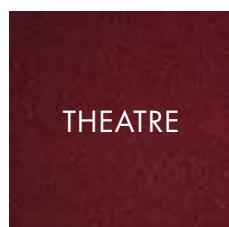
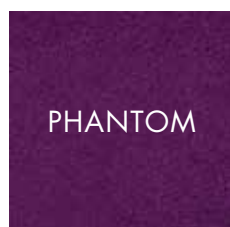
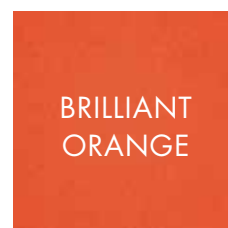



W
E
K
E
N
E
A
D
A

ETCH™
PICK YOUR
PATTERN

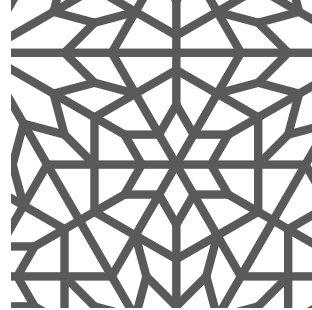

MOSAIC



BAROQUE

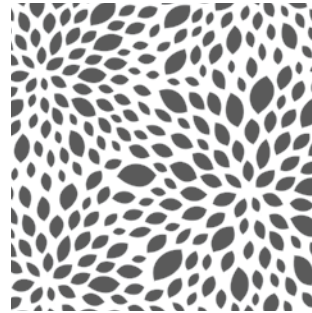

BURST



FLAMINGO



BARLEY



TROPICS



ALPHABET SOUP



FADE AWAY



SCHOOL DAYS



STITCH



PINSTRIPES



HARLEQUIN

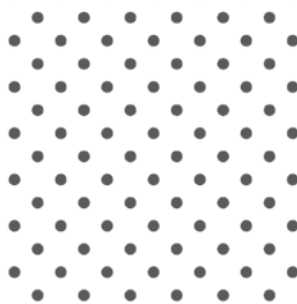

DOTS



ZOO



JAWS

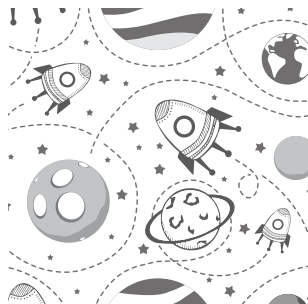

COSMIC